

Owner's Manual & Safety Instructions

Save This Manual Keep this manual for the safety warnings and precautions, assembly, operating, inspection, maintenance and cleaning procedures. Write the product's serial number in the back of the manual near the assembly diagram (or month and year of purchase if product has no number). Keep this manual and the receipt in a safe and dry place for future reference.

20c

PITTSBURGH®

3 TON HEAVY DUTY FLOOR JACK



Item	56621
Weight Capacity	3 Tons (6,000 lb.)
Maximum Height	18-1/4"
Minimum Height	5-1/8"

Visit our website at: <http://www.harborfreight.com>
Email our technical support at: productsupport@harborfreight.com

When unpacking, make sure that the product is intact and undamaged. If any parts are missing or broken, please call 1-888-866-5797 as soon as possible.

Copyright© 2019 by Harbor Freight Tools®. All rights reserved.
No portion of this manual or any artwork contained herein may be reproduced in any shape or form without the express written consent of Harbor Freight Tools. Diagrams within this manual may not be drawn proportionally. Due to continuing improvements, actual product may differ slightly from the product described herein.
Tools required for assembly and service may not be included.

⚠ WARNING

Read this material before using this product. Failure to do so can result in serious injury.
SAVE THIS MANUAL.

Table of Contents





Safety	3	Maintenance	7
Setup	4	Parts List and Assembly Diagram.....	10
Operation.....	5	Warranty	12

SAFETY

SETUP

OPERATION

MAINTENANCE

WARNING SYMBOLS AND DEFINITIONS	
	This is the safety alert symbol. It is used to alert you to potential personal injury hazards. Obey all safety messages that follow this symbol to avoid possible injury or death.
	Indicates a hazardous situation which, if not avoided, will result in death or serious injury.
	Indicates a hazardous situation which, if not avoided, could result in death or serious injury.
	Indicates a hazardous situation which, if not avoided, could result in minor or moderate injury.
	Addresses practices not related to personal injury.

IMPORTANT SAFETY INFORMATION

Floor Jack Safety Warnings

1. Study, understand, and follow all instructions before operating this device.
2. Do not exceed rated capacity.
3. Use only on hard, level surfaces.
4. Lifting device only. Immediately after lifting, support the vehicle with appropriate means.
5. Do not move or dolly the vehicle while on the jack.
6. Failure to heed these markings may result in personal injury and/or property damage.
7. Lift only areas of the vehicle as specified by the vehicle manufacturer.
8. No alterations shall be made to this product.
9. Never work on, under or around a load supported only by this device.
10. Do not adjust safety valve.
11. Wear ANSI-approved safety goggles and heavy-duty work gloves during use.
12. Keep clear of load while lifting and lowering.
13. Lower load slowly.
14. Apply parking brake and chock tires before lifting vehicle.
15. Lift vehicle only at manufacturer recommended locations.
16. Inspect before every use; do not use if parts are loose or damaged.
17. Do not use for aircraft purposes.
18. The warnings, precautions, and instructions discussed in this manual cannot cover all possible conditions and situations that may occur. The operator must understand that common sense and caution are factors, which cannot be built into this product, but must be supplied by the operator.
19. The Handle socket may be held down by a clip under tension. Wear ANSI-approved safety goggles before freeing Handle socket. Remove clip carefully.

IMPORTANT! Before first use:

Check hydraulic fluid level and fill to 1/4" below the fill port as needed as stated on page 5. Thoroughly test the Jack for proper operation. If it does not work properly, bleed air from its hydraulic system as stated on page 5.



SAVE THESE INSTRUCTIONS.

Setup - Before Use:



Read the **ENTIRE IMPORTANT SAFETY INFORMATION** section at the beginning of this manual including all text under subheadings therein before set up or use of this product.

Note: For additional information regarding the parts listed in the following pages, refer to *Parts List and Assembly Diagram* on page 10.

Functions

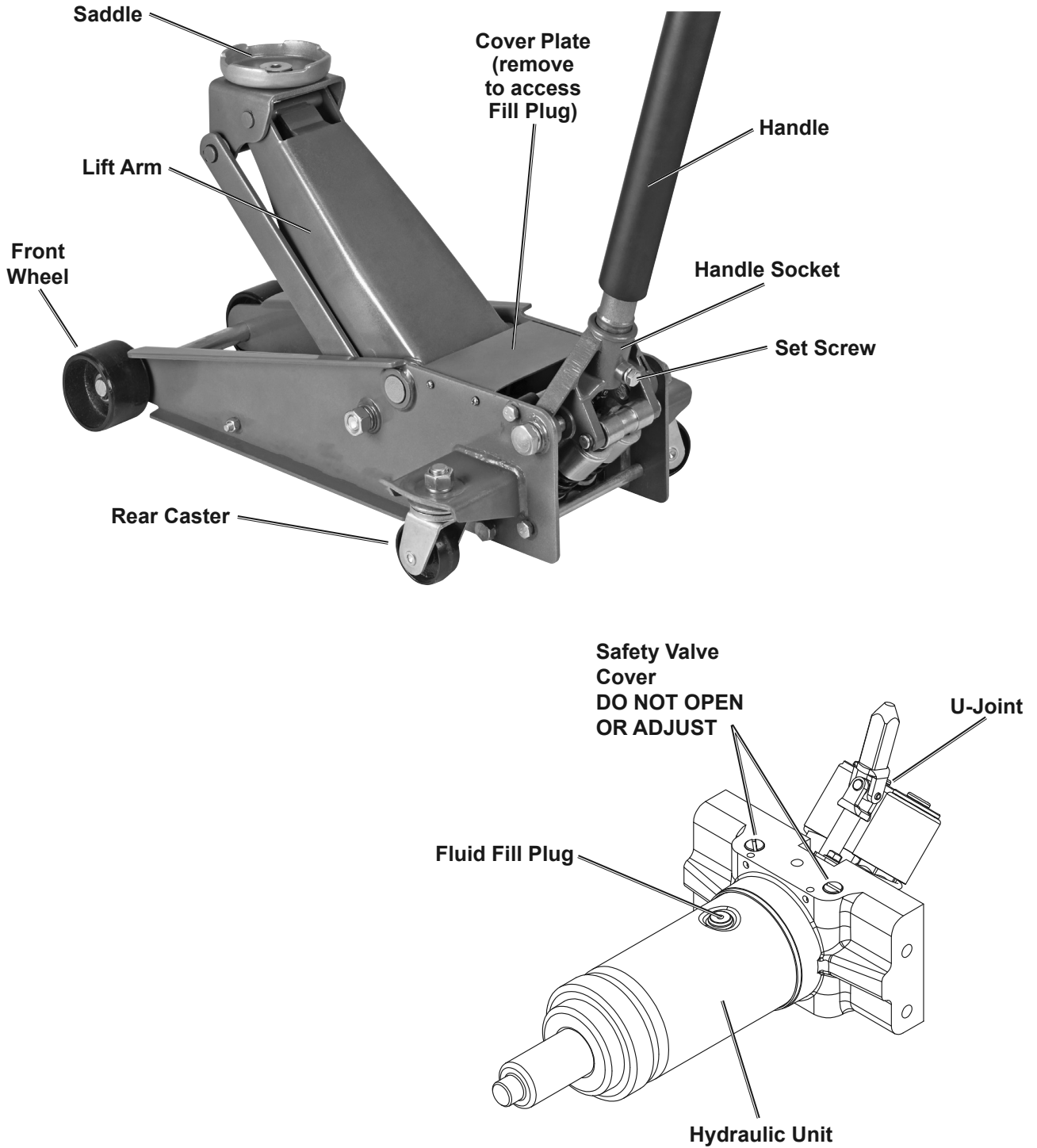

Figure A

Operating Instructions



Read the **ENTIRE IMPORTANT SAFETY INFORMATION** section at the beginning of this manual including all text under subheadings therein before set up or use of this product.

Tool Set Up

Attaching the Handle

CAUTION! The Handle socket may be held down by a clip under tension. Wear ANSI-approved safety goggles before freeing Handle socket. Remove clip carefully.

1. Fasten the Upper Handle to the Lower Handle.
2. Loosen the Set Screw and insert the assembled Handle into the Handle Socket.
3. Tighten the Set Screw.

Bleeding

1. Turn handle counterclockwise to open Release Valve.
2. Remove four screws holding on the Cover Plate.
3. Remove Oil Fill Plug and top off hydraulic oil.
4. Apply pressure to saddle and quickly pump handle several times.
5. Check Oil Fill Hole again and top off with hydraulic oil if necessary.
6. Replace the Oil Fill Plug and Cover Plate. Turn handle clockwise to close Release Valve.
7. Test several times for proper operation before attempting to lift a load.

Adding Hydraulic Fluid

8. Remove the Cover Plate.
9. Remove the Fluid Fill Plug.
10. Add high grade hydraulic fluid into the fill hole slowly until the fluid reaches the top of the hole.
11. Replace the Fill Plug and Cover Plate.

Note: Do not touch the Handle when adding the hydraulic fluid.

General Operating Instructions

Lifting

⚠️WARNING

Park vehicle on a flat, level, solid, surface safely away from oncoming traffic. Turn off the vehicle's engine. Place the vehicle's transmission in "PARK" (if automatic) or in its lowest gear (if manual). Set the vehicle's emergency brake. Then, chock the wheels that are not being lifted.

1. Turn the Handle counterclockwise to open the release valve and lower the Jack. Once the Jack is fully lowered, turn the Handle firmly clockwise to close the valve.
2. Carefully position the Saddle of the Jack under the vehicle manufacturer's recommended lifting point. (See vehicle manufacturer's owner's manual for location of frame lifting point.)
3. Pump the Handle until the top of the Jack's Saddle has nearly reached the vehicle lifting point. Position the Saddle directly under the vehicle's lifting point.
4. To lift the vehicle, pump the Handle of the Jack. Use smooth, full strokes.
5. Once the vehicle is raised, slide a jack stand of appropriate capacity (not included) under a proper lifting point referred to in the vehicle owner's manual. Always use two jack stands. Position them at the same point on each side of the vehicle.
6. Center the vehicle's lifting point(s) on the saddle of the jack stand(s). Set the jack stand(s) to the same height according to the manufacturer's instructions, making sure that they lock securely into position.
7. Slowly turn the Handle counterclockwise to open the release valve and lower the vehicle onto the saddle(s) of the jack stand(s). Then, turn the Handle firmly clockwise to close the valve.

WARNING! The rated capacity of jack stands is per pair, not the individual capacities combined unless specifically noted on the product by the jack stand manufacturer. Do not exceed rated jack stand capacity. Ensure that the vehicle support points are fully seated in the saddle of both jack stands. Use a matched pair of jack stands per vehicle to support one end only. Failure to do so may result in the load suddenly falling, which may cause personal serious injury and/or property damage.

Lowering

1. Carefully remove all tools, parts, etc. from under the vehicle.
2. Position the Saddle under the lifting point. Turn the Handle firmly clockwise and raise load high enough to clear the jack stands, then carefully remove jack stands.
3. Slowly turn the Handle counterclockwise (never more than 1/2 full turn) to lower the vehicle onto the ground.
4. Lower the Jack completely. Then, store in a safe, dry location out of reach of children.

PITTSBURGH[®]

Maintenance and Servicing



Procedures not specifically explained in this manual must be performed only by a qualified technician.

WARNING

TO PREVENT SERIOUS INJURY FROM TOOL FAILURE:

Do not use damaged equipment. If abnormal noise or vibration occurs, have the problem corrected before further use.

Cleaning, Maintenance, and Lubrication

1. **BEFORE EACH USE**, inspect the general condition of the Jack. Check for:
 - loose or missing hardware
 - misalignment or binding of moving parts
 - cracked or broken parts
 - any condition that may affect its safe operation.If a problem occurs, have the problem corrected before further use.
Do not use damaged equipment.
2. **BEFORE EACH USE**, thoroughly test the Jack for proper operation prior to its actual use. If the Jack appears not to be working properly, follow Bleeding instructions on page 5.
3. **AT LEAST ONCE EVERY THREE YEARS**, change the hydraulic fluid:
 - a. With the Jack fully lowered, remove the Fluid Fill Plug on the side of the Housing.
 - b. Tip the Jack to allow the old hydraulic fluid to drain out of the Housing completely, and dispose of the old hydraulic fluid in accordance with local regulations.
 - c. With the Jack upright, completely fill the Housing with a high quality hydraulic fluid (not included) until the fluid is 1/4" below the fill hole.
 - d. Open the valve by turning the Handle counterclockwise and pump the Handle to bleed air from the system.
 - e. Recheck fluid level and re-fill as needed.
 - f. Reinstall the Fluid Fill Plug.
4. **AFTER EACH USE**, wipe dry with a clean cloth. Store the Jack in a safe, dry location out of reach of children and other non-authorized people.

Troubleshooting

⚠️ WARNING

TO PREVENT SERIOUS INJURY:

Use caution when troubleshooting a malfunctioning jack. Stay well clear of the supported load. Completely resolve all problems before use. If the solutions presented in the Troubleshooting guide do not solve the problem, have a qualified technician inspect and repair the jack before use.

After the jack is repaired: Test it carefully without a load by raising and lowering it fully, checking for proper operation, **BEFORE RETURNING THE JACK TO OPERATION.**

DO NOT USE A DAMAGED OR MALFUNCTIONING JACK!

POSSIBLE SYMPTOMS						PROBABLE SOLUTION (Make certain that the jack is not supporting a load while attempting a solution.)
Jack will not lift at its weight capacity	Saddle lowers under load	Pump stroke feels spongy	Saddle will not lift all the way	Handle moves up when jack is under load	Fluid leaking from fill plug	
X	X					Check that Release Valve is fully closed. Bleed air from the system.
X	X			X		Valves may be blocked and may not close fully. To flush the valves: 1. Lower the Saddle and securely close the release valve. 2. Manually lift the Saddle several inches. 3. Open the release valve and force the Saddle down as quickly as possible.
X		X	X			Jack may be low on fluid. Check the fluid level and refill if needed. Jack may require bleeding - see instructions on Bleeding on page 5.
					X	Unit may have too much hydraulic fluid inside; check fluid level and adjust if needed.

SAFETY

SETUP

OPERATION

MAINTENANCE

PLEASE READ THE FOLLOWING CAREFULLY

THE MANUFACTURER AND/OR DISTRIBUTOR HAS PROVIDED THE PARTS LIST AND ASSEMBLY DIAGRAM IN THIS MANUAL AS A REFERENCE TOOL ONLY. NEITHER THE MANUFACTURER OR DISTRIBUTOR MAKES ANY REPRESENTATION OR WARRANTY OF ANY KIND TO THE BUYER THAT HE OR SHE IS QUALIFIED TO MAKE ANY REPAIRS TO THE PRODUCT, OR THAT HE OR SHE IS QUALIFIED TO REPLACE ANY PARTS OF THE PRODUCT. IN FACT, THE MANUFACTURER AND/OR DISTRIBUTOR EXPRESSLY STATES THAT ALL REPAIRS AND PARTS REPLACEMENTS SHOULD BE UNDERTAKEN BY CERTIFIED AND LICENSED TECHNICIANS, AND NOT BY THE BUYER. THE BUYER ASSUMES ALL RISK AND LIABILITY ARISING OUT OF HIS OR HER REPAIRS TO THE ORIGINAL PRODUCT OR REPLACEMENT PARTS THERETO, OR ARISING OUT OF HIS OR HER INSTALLATION OF REPLACEMENT PARTS THERETO.

SAFETY

SETUP

OPERATION

MAINTENANCE

Record Product's Serial Number Here: _____

Note: If product has no serial number, record month and year of purchase instead.

Note: Some parts are listed and shown for illustration purposes only, and are not available individually as replacement parts.

Parts List and Assembly Diagram

Parts List

SAFETY

SETUP

OPERATION

MAINTENANCE

Part	Description	Qty
1	Saddle	1
2	Saddle Bolt	1
3	Lift Arm Assembly	1
4	Radius Link	2
5	Snap Ring	2
6	Washer	2
7	Cotter Pin	1
8	Spring	2
9	Front Wheel	2
11	Washer	2
12	Snap Ring	2
14	Lock Washer	4
16	Radius Link Stud	2
17	Lock Washer	4
18	Nut	2
19	Frame Tie Rod	2
20	Screw	4
22	Handle Bolt	2
23	Lock Washer	2
24	Bolt	4
25	Lock Washer	4
26	Left Plate Assembly	1
27	Right Plate Assembly	1
28	Rear Caster Assembly	2
29	Bearing	2
30	Snap Ring	2
31	Nut	2
32	Cover Plate	1
33	Screw	4
34	Ram Plunger	1
35	Bushing Cover	1
36	Washer	1
37	Sealing Ring	1
38	Top Nut	1
39	O-Ring	1
40	Wedge Ring	2
41	Reservoir	1
42	Cylinder	1
43	Washer	1
44	O-Ring	1
45	Oil Seal	1
46	Base	1
47	Ball	5
48	Release Valve Assembly	1
49	O-Ring	1
50	Ball	2
51	Washer	1
52	Lock Washer	1

Part	Description	Qty
53	Hex Bolt	1
54	Screw	1
55	O-Ring	1
56	Screw Safety Valve	1
57	Spring	1
58	Valve	1
59	Ball	1
60	Bolt	1
61	Back-Up Washer	1
62	O-Ring	1
63	Spring	1
64	Pump Piston	1
65	O-Ring	2
66	Pump	1
67	Washer	1
68	Pump Core Spring	1
69	Spring Sleeve	1
70	Spring Stop Sheet	1
71	Snap Ring	1
72	Pump Piston	1
73	Washer	2
74	O-Ring	2
75	Pump	1
76	Washer	1
77	O-Ring	1
78	Washer	1
79	Pump Core Spring	1
80	Spring Sleeve	1
81	Spring Stop Sheet	1
82	Snap Ring	1
83	Filter	2
84	Washer	1
85	Handle Base	1
86	Pin	1
87	Roller	1
88	Snap Ring	1
89	Bolt	1
90	Lower Handle	1
92	Upper Handle	1
93	Foam	1
94	Rubber Block	1
95	Snap Ring	1
96	Lift Arm Shaft	1
97	Snap Ring	2
98	Grease Fitting	1
99	Core Tube Assembly	1
100	Snap Ring	2
101	Handle Lock Button	1

Assembly Diagram

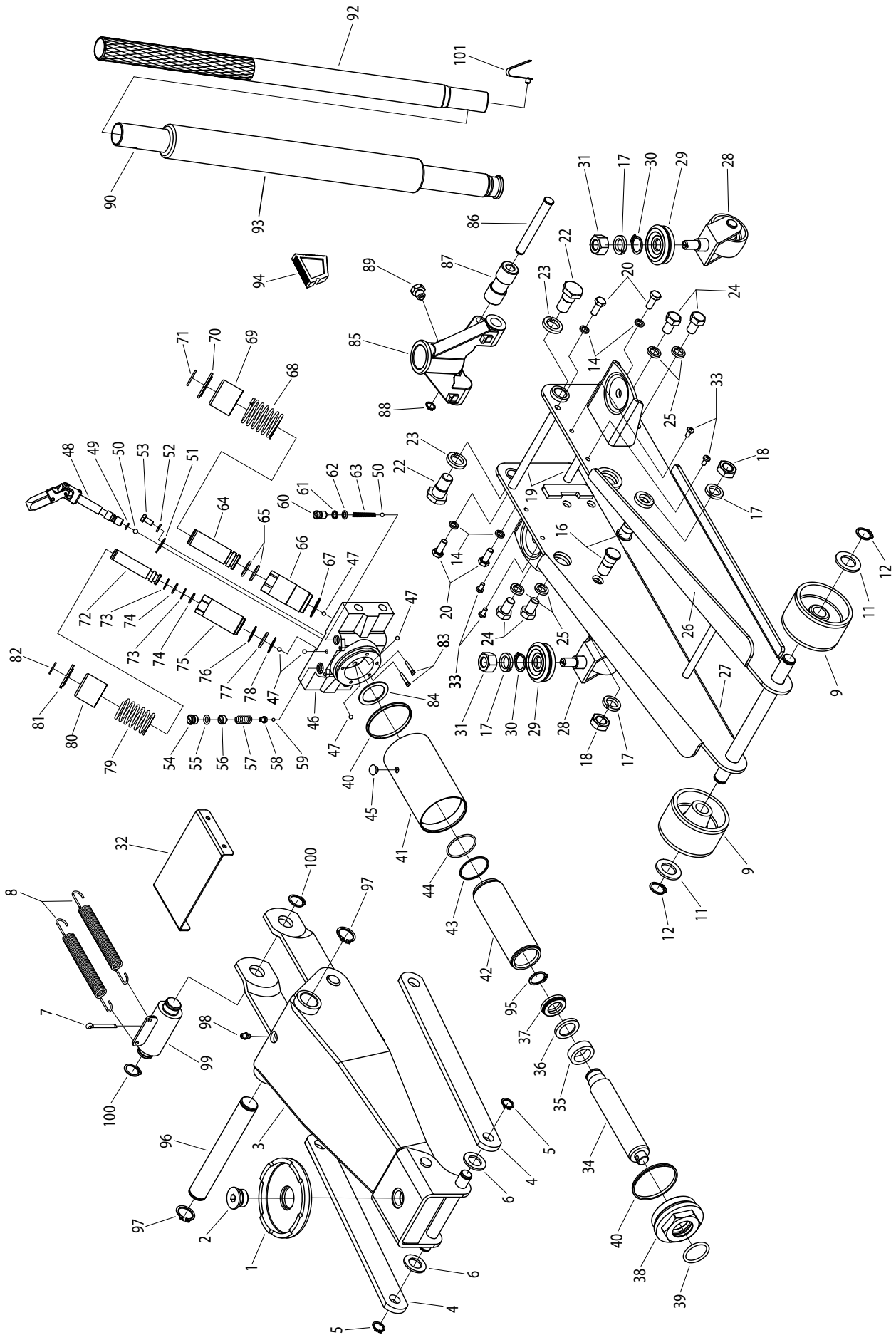

SAFETY

SETUP

OPERATION

MAINTENANCE

Limited 90 Day Warranty

Harbor Freight Tools Co. makes every effort to assure that its products meet high quality and durability standards, and warrants to the original purchaser that this product is free from defects in materials and workmanship for the period of 90 days from the date of purchase. This warranty does not apply to damage due directly or indirectly, to misuse, abuse, negligence or accidents, repairs or alterations outside our facilities, criminal activity, improper installation, normal wear and tear, or to lack of maintenance. We shall in no event be liable for death, injuries to persons or property, or for incidental, contingent, special or consequential damages arising from the use of our product. Some states do not allow the exclusion or limitation of incidental or consequential damages, so the above limitation of exclusion may not apply to you. THIS WARRANTY IS EXPRESSLY IN LIEU OF ALL OTHER WARRANTIES, EXPRESS OR IMPLIED, INCLUDING THE WARRANTIES OF MERCHANTABILITY AND FITNESS.

To take advantage of this warranty, the product or part must be returned to us with transportation charges prepaid. Proof of purchase date and an explanation of the complaint must accompany the merchandise. If our inspection verifies the defect, we will either repair or replace the product at our election or we may elect to refund the purchase price if we cannot readily and quickly provide you with a replacement. We will return repaired products at our expense, but if we determine there is no defect, or that the defect resulted from causes not within the scope of our warranty, then you must bear the cost of returning the product.

This warranty gives you specific legal rights and you may also have other rights which vary from state to state.

PITTSBURGH[®]

26541 Agoura Road • Calabasas, CA 91302 • 1-888-866-5797