***INSTALLATION
INSTRUCTIONS***

***12,000 Pound
4- Post Models***

Revision 120100

Bend-Pak[®]
ABOVE-GROUND LIFTS

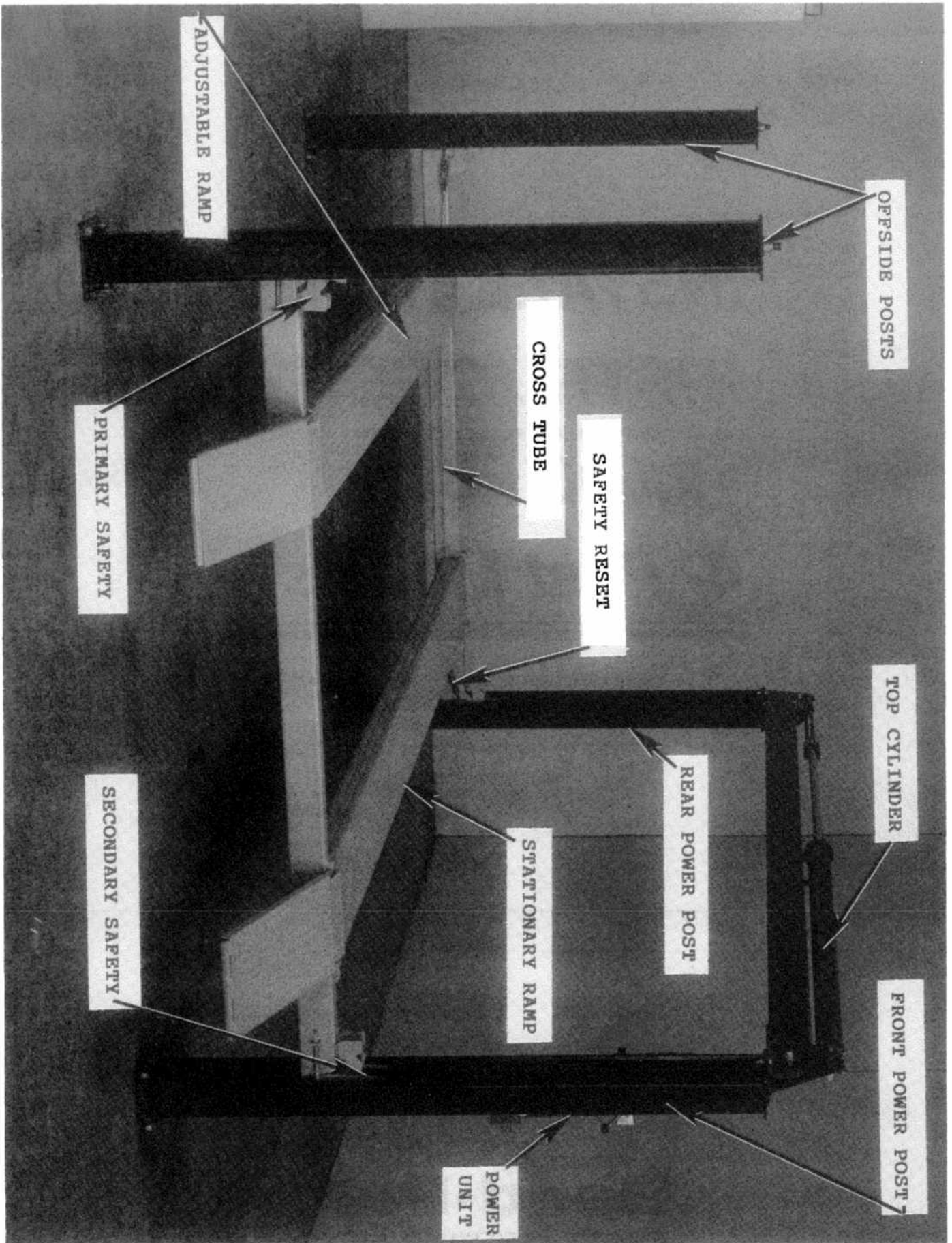

TABLE OF CONTENTS

Tools	4
Lift Site	6, 7
Concrete Specifications	7, 8
Step-One, Power Side Assembly	10
Step-Two, Anchoring Power Side Assembly	12
Step-Three, Anchoring Offside Posts	13
Step-Four, Connecting Chains	14, 15
Step-Five, Positioning Ramps	16
Step-Six, Power Unit Installation	17
Step-Seven, Hose Connections	18
Step-Eight, Safety Assemblies	19, 20, 21
Step-Nine, Installing Ramp Locks	22
Step-Ten, Start-Up	23
Maintenance	24
Troubleshooting	25
Maintenance Records and Notes	26,27

WARRANTY NOTICE

**These instructions must be followed to insure proper installation
and operation of your lift.**

Failure to comply with these instructions will void warranty.

TOOLS REQUIRED TO SET UP LIFT

1. Open or box end wrenches - (1/2", 9/16", 3/4", 1-13/16").
2. 1/2" drive ratchet handle with 1/2" and 3/4" sockets.
3. Crescent wrenches - (12" & 15").
4. Pliers, needle nose, small.
5. Hammer, medium.
6. Punch to align chain, small.
7. Hex Allen wrench, set.
8. Carpenters chalk line - 25 feet minimum.
9. Level - Carpenters or small magnetic.

RENTAL TOOLS

1. Rotary hammer.
2. Carbide drill bit - 3/4" diameter.

CAUTION

SPECIFICATIONS OF CONCRETE

SPECIFICATIONS OF CONCRETE MUST BE ADHERED TO. FAILURE TO DO SO MAY RESULT IN LIFT AND/OR VEHICLE FALLING.

Floors must be level and concrete must be in good condition (3,000 PSI minimum). Four inch minimum thickness, steel reinforced per commercial practice with a 28 day minimum cure.

PADS:

Pads must be minimum two feet square with a minimum thickness of 1-foot. Concrete must be in good condition (3,000 PSI minimum) steel reinforced per commercial practice with a 28 day minimum cure.

NOTE: This lift was designed to be placed indoors, however, if installed outside, proper precautions should be taken to protect the POWER UNIT from damp weather conditions.

IMPORTANT NOTICE

A level floor is suggested for a proper installation site and will ensure level lifting. Small differences in floor slopes may be compensated for by proper shimming. If a floor is of questionable slope, consider a survey of the site and/or the possibility of pouring a new level concrete slab section. Simply stated for optimum level lifting, the equipment, at best, can lift only as level as the floor on which it is located... and should not be expected to compensate for drastic floor slope difference.

CAUTION

The equipment described in this manual could be potentially dangerous if improperly or carelessly operated. For the protection of all persons and equipment, only competently trained operators who are critically aware of the proper operating procedures, potential dangers, and specific application of this equipment should be allowed to touch the controls at any time.

Safe operation of this equipment is dependent on use in compliance with the operation procedures outlined in this manual along with the maintenance and inspection procedures with consideration of prevailing conditions.

The equipment described in this manual is neither designed nor intended for any application alone or in conjunction with any other equipment that involves the lifting or moving of persons.

IMPORTANT NOTICE

Do not install this unit on any asphalt surface.

Do not install this unit on any surface other than concrete conforming to the minimum specifications stated in the general floor requirements. (See page 4 of this manual).

Do not install on expansion seams or on cracked, defective concrete. Check with building architect.

Do not install this unit on a second floor with a basement beneath without written authorization from the building architect.

INSTALL THIS EQUIPMENT ON CONCRETE ONLY!

BEFORE INSTALLING LIFT

Before installing a Bend-Pak hoist, there are several items that should be checked. Each repair shop bay is different and in an attempt to prevent oversights in this area all of the following information should be checked.

1. **OVERHEAD OBSTRUCTIONS:** The area in which the lift will be located should have no over head obstructions. Heaters, building supports, electrical conduit, etc.
2. **DEFECTIVE CONCRETE:** Visually look over the bay floor area. The lift cannot be installed on expansion seams, or concrete that appears to be cracked. The lift is only as strong as the floor it is installed on.
3. **TEST DRILL THE FLOOR:** Test drilling the floor will provide a good indication of how deep the concrete is in each bay. It is considered good practice to test drill each bay when more than one lift is being installed.
4. **FLOOR REQUIREMENTS:** This information is found on pages 4 and 5 of this manual.
5. **POWER SUPPLY:** The standard Bend-Pak power unit is 220 VAC single phase. The power supply should be available prior to installation. It is advisable to have a licensed electrician do all electrical wiring and confirm that hook-up complies with local electrical codes.
6. **BAY SIZE:** Bend-Pak manufactures a number of above ground hydraulic lifts. All items are designed to service individual shop needs. The overall width of each lift will vary (refer to Section II). Additional information regarding the bay size can be obtained from Bend-Pak or your local Bend-Pak distributor.



EXAMPLES OF CONCRETE PADS

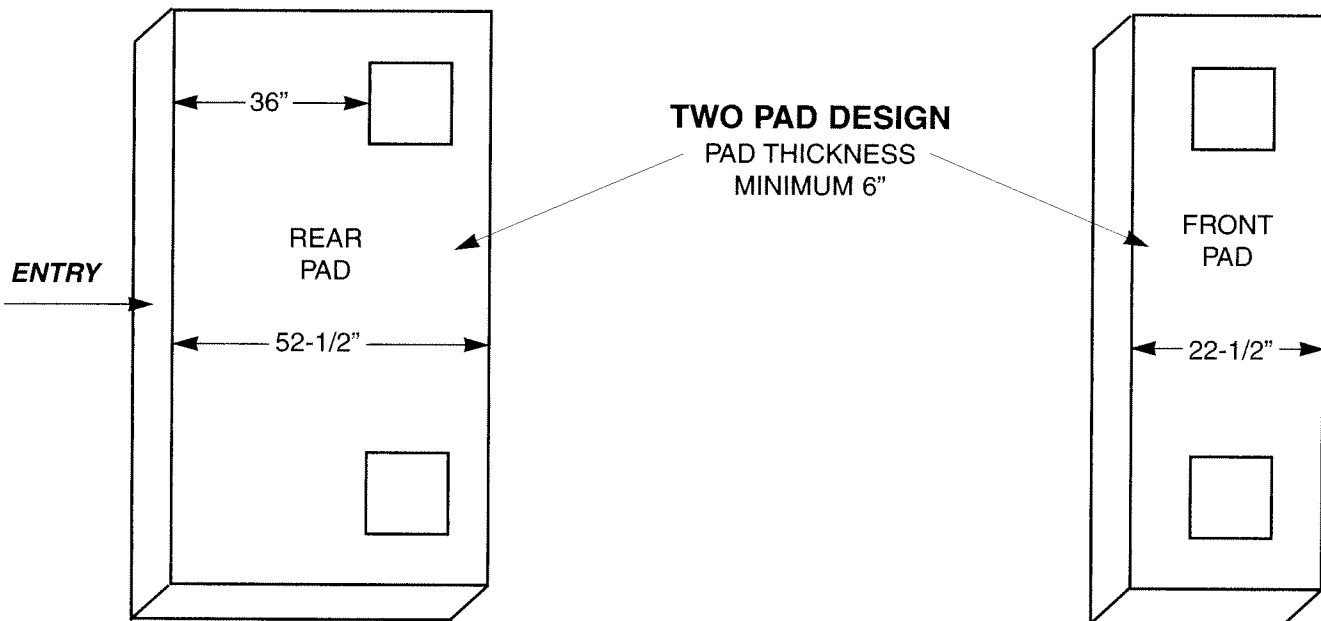
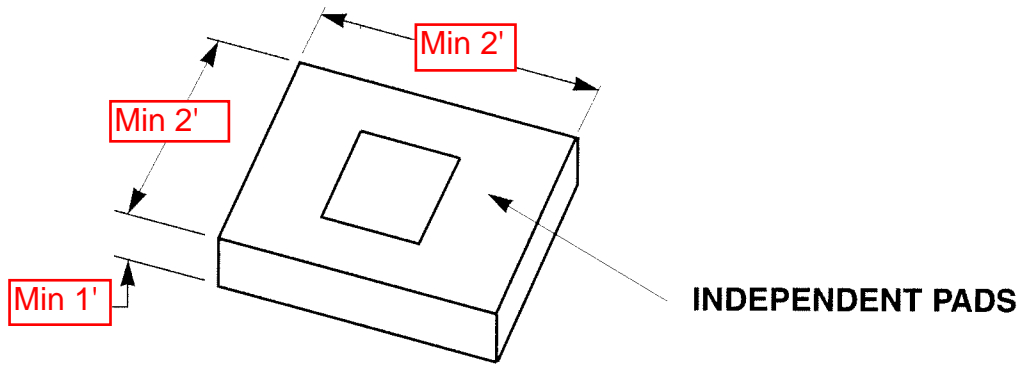
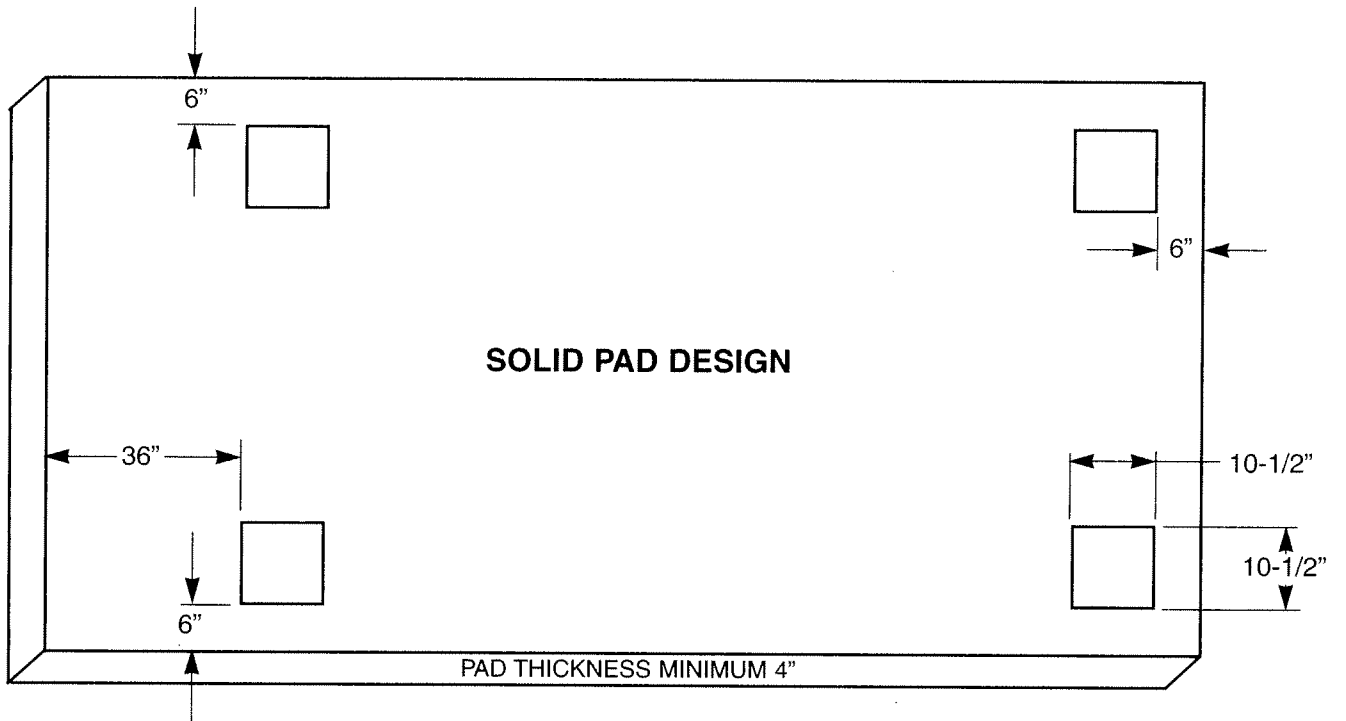

LAYOUT DIAGRAM

MODEL	A	B	C
BP-12SS BP-12FW BP-12LS BP-12AL FL-12	181" 4597mm	124-1/2" 3162mm	219-1/2" 5575mm
BP-12 BP-12FWX BP-12LSX BP-12ALX	205" 5207mm	136-1/2" 3467mm	246-1/2" 6261mm
BP-12X	254" 6452mm	136-1/2" 3467mm	288-1/2" 7328mm

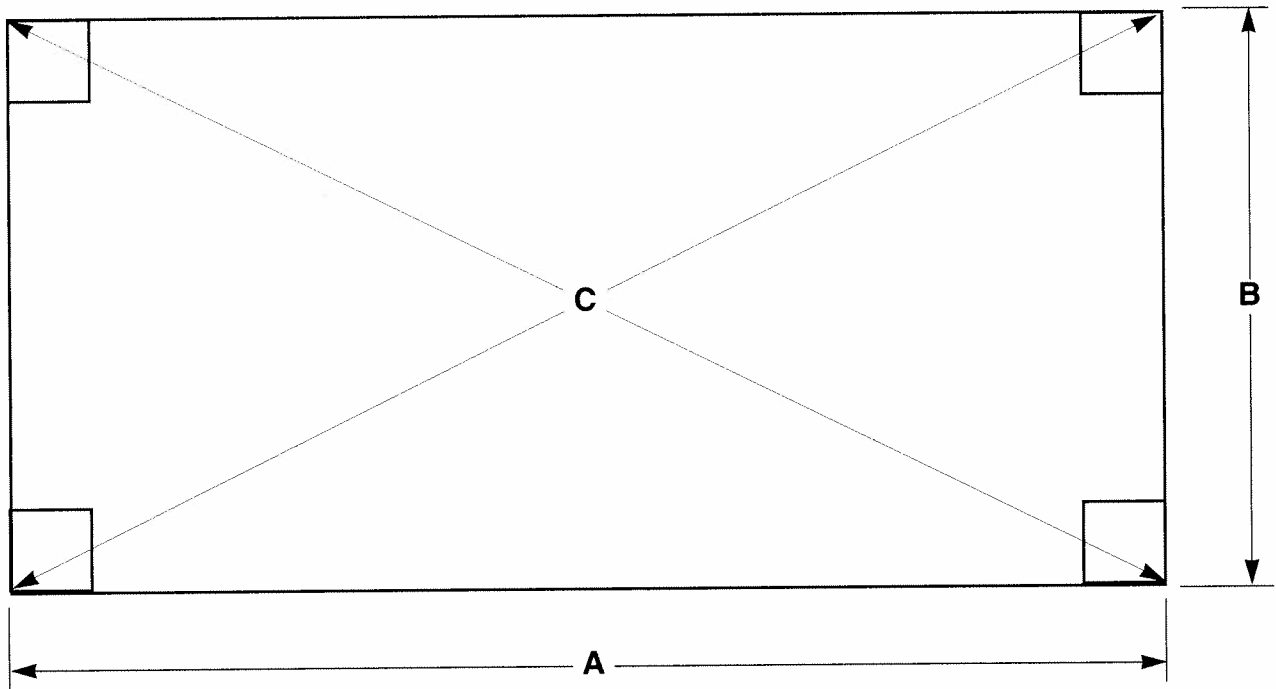

All dimensions shown are plus or minus 1/8".
All dimensions are from the outside edge of the base plates.
Squareness must be held within 1/8".

CAUTION
Faulty installation due to improper placement of columns
can cause malfunction of lift.

MARKING FLOOR

Once location is determined use a carpenter's chalk line and establish overall rectangular layout as shown in layout diagram. Pay special attention to maintain the 1/8" tolerance and overall squareness of your lift. **THIS IS VERY IMPORTANT.**

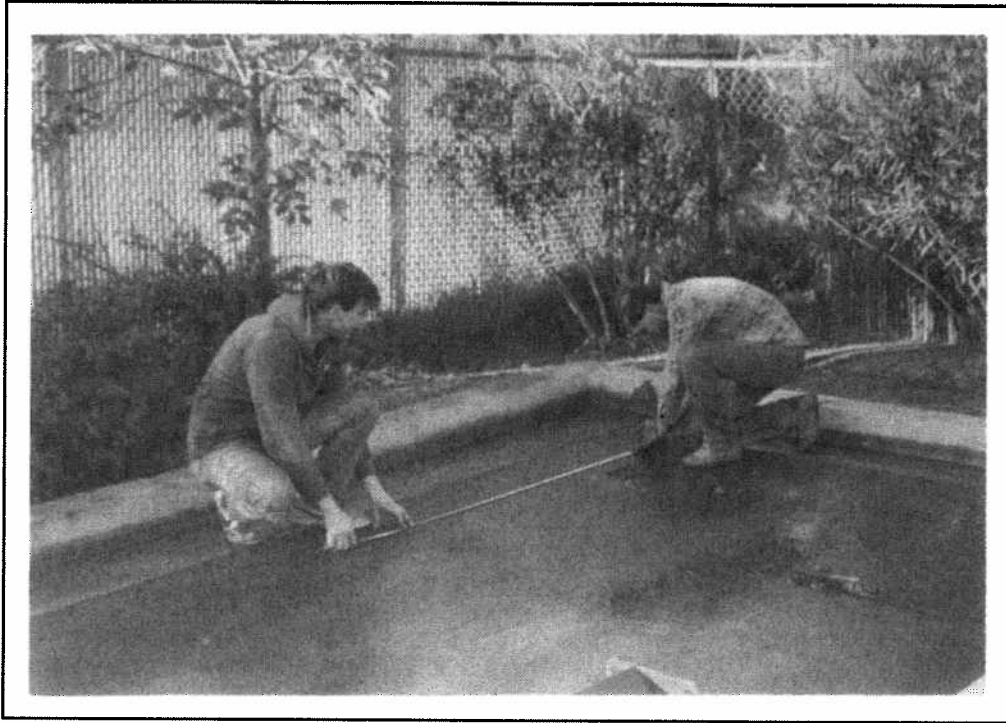

NOTE: Take special notice of the POWER BEAM location. Your lift may be installed with the beam on either side. By having the POWER BEAM on the right, the POWER UNIT will be placed near vehicles right rear tire. If installed on the left, the POWER UNIT will then be near vehicles left front tire.

ALIGNMENT MODELS: On these lifts, the POWER BEAM can only be placed on one side. If the bulkhead fitting is attached to the front side of the STATIONARY RAMP where the turnplates are located then, the POWER BEAM **must** be placed on the left/drivers side of the lift. If the bulkhead fitting is located instead by the rear slip-plates, the POWER BEAM **must** be positioned on the right/passenger side.

STEP ONE

POWER SIDE ASSEMBLY

Begin assembly of POWER BEAM and POWER SIDE posts.

Parts Needed:

1. FRONT POWER POST. (This post has four mounting studs for motor.)
2. POWER BEAM assembly.
3. REAR POWER POST.

Note: FRONT and REAR POWER POSTS have square cutouts on top with holes to mount POWER BEAM. Refer to the bottom of page 9 for locations of FRONT POWER POST. POWER BEAM will be positioned so that cylinder hydraulic ports are on the same side as the FRONT POWER POST. THE 1/2"-13 x 1- 3/4" BOLTS USED IN SHIPMENT FOR ATTACHING POWER BEAM TO SHIPPING ANGLES ARE UTILIZED IN POWER BEAM ASSEMBLY.

If a forklift is available, the POWER BEAM can be raised into position and placed on top of appropriate posts. If forklift is not available the POWER BEAM can be assembled on the floor in the following manner then raised to the upright position.

Pay attention how assembly is done on the floor to assure correct position of components when raised. Center the slots in the POWER BEAM with the slots in top of the POWER POST and tighten. Double check assuring FRONT POWER POST is located near hydraulic cylinder ports.

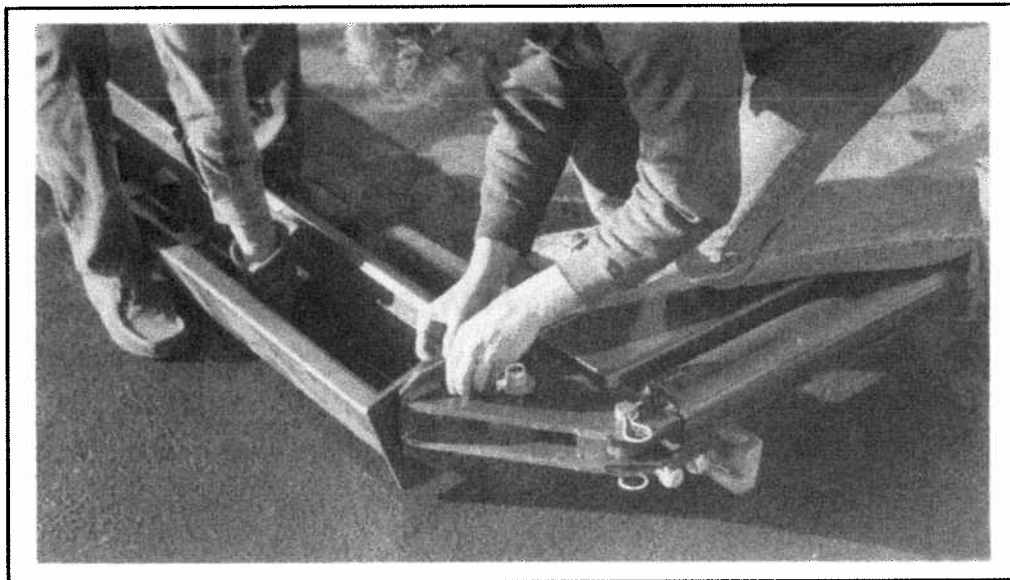

Assemble the REAR POWER POST to the POWER BEAM as shown below using two 1/2" -13 x 1-1/4" hex head bolts, nuts, and lockwashers. Center the slots in power beam assembly with the slots in the top of the REAR POWER POST. Push bolts through holes and secure.

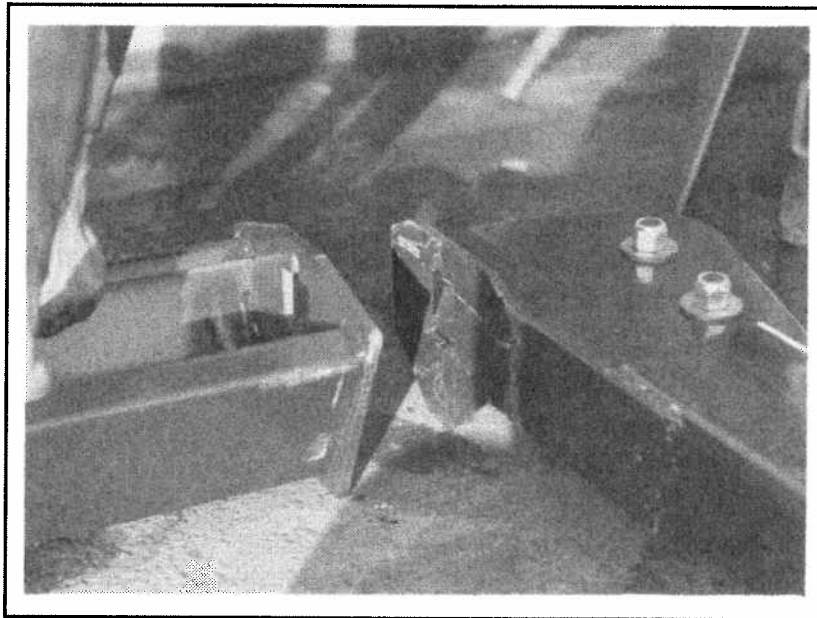

Tighten all bolts and drop chains through slots in top of power posts. Lift POWER BEAM assembly to an upright position placing mounting pads into corners of the chalk line layout.



If the fork lift is available, power posts may be set upright and POWER BEAM lifted and set in place.

NOTE: It is helpful to loosen 1/2"-13 x 1-1/4" bolts that secure the POWER BEAM to the posts in order to freely position the posts to align them with the chalk line. Be certain to retighten the bolts after the posts are anchored.

STEP TWO

ANCHORING THE POWER SIDE ASSEMBLY

With power side assembly in the upright position you are now ready to drill anchor holes and secure the posts to the concrete.

NOTE: Before proceeding double check length measurement and assure power post bases are aligned perfectly with chalk line.

Using the prescribed rotary hammer and 3/4" carbide drill bit begin drilling anchor holes. Using the power post base to locate holes, drill approximately 4-1/2" deep.

PAY CAREFUL ATTENTION TO REMOVE ALL DUST FROM HOLE AFTER DRILLING! After drilling each hole insert anchor bolt as described below before proceeding with next hole.

NOTE: BE SURE WASHER AND NUT IS ON ANCHOR BOLT BEFORE HAMMERING IN CONCRETE TO PROTECT THREADS. Tap firmly with hammer to seat cement anchor in hole making sure that if shimming is necessary enough threads are left exposed. Do not tighten until final adjustments in dimensions and plumbness are made. Recheck alignment after each anchor bolt is installed.

Using a level, plumb posts so that they are perpendicular. Use shims under mounting pads so that when anchor bolts are tightened posts will be straight. Tighten all four anchor bolts and check plumbness again. Loosen nuts and add shims if necessary. **Maximum shimming can not exceed one quarter inch. If more is needed consult factory.**

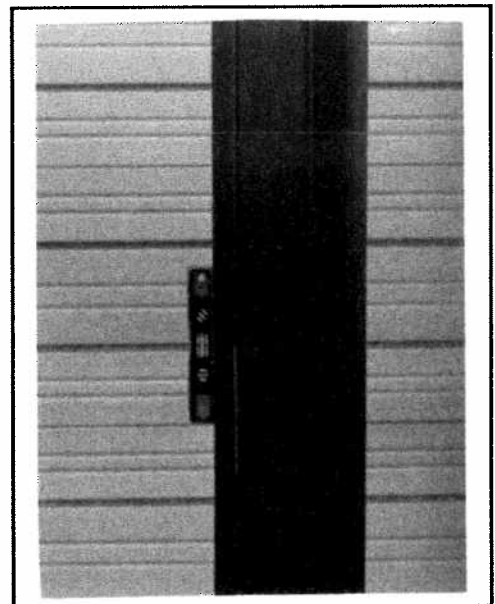

STEP THREE

ANCHORING OFF-SIDE POSTS AND POSITIONING CROSS TUBES

Position OFFSIDE POSTS in appropriate locations according to chalkline.

NOTE: Check and recheck all measurements and post positions prior to anchoring OFFSIDE POSTS. To cross check diagonal measurement use the inside holes on the post floor mounting plates making sure both diagonal measurements are equal.

Anchor OFFSIDE POSTS following procedures as outlined in STEP TWO.

Position CROSS TUBES making sure the safety cylinders are located inside as shown on the following diagram.

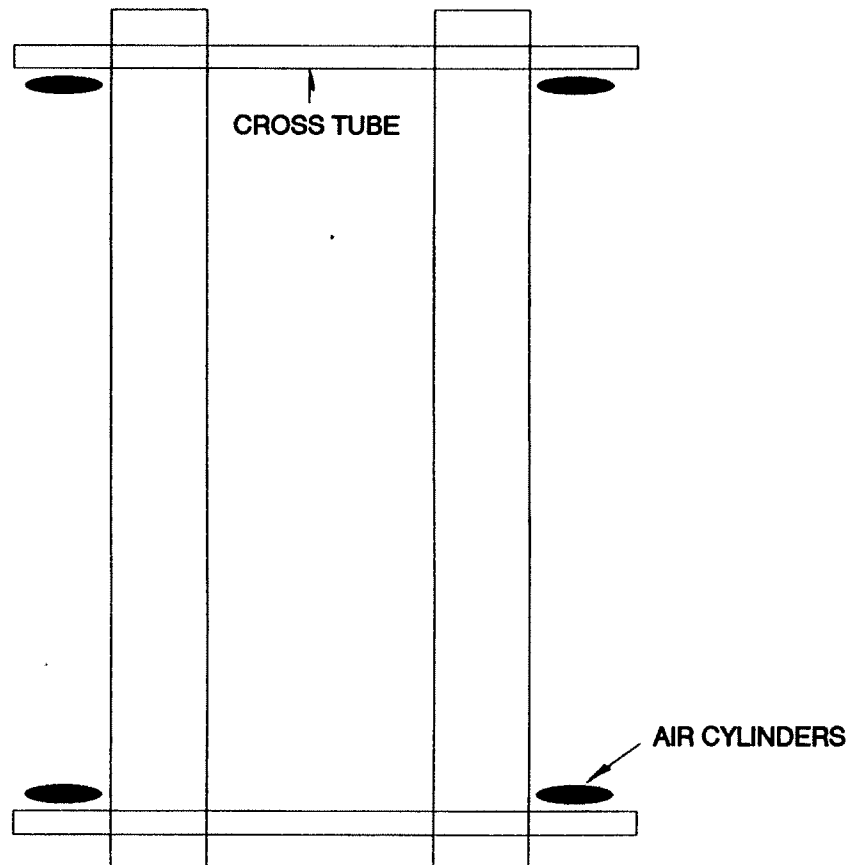

NOTE: It is helpful to rest the CROSS TUBES on the bottom lattices in the post prior to connecting chains.

STEP FOUR

CONNECTING CHAINS

It is necessary to extend the TOP CYLINDER prior to connecting chains. To do this remove plastic plugs from cylinder to extend shaft letting chains reach the CROSS TUBES. It may take air pressure to extend TOP CYLINDER if pulling chains is not effective. To do this remove plastic plugs on TOP CYLINDER and blow air in port farthest from chrome cylinder shaft.

The two POWER CHAINS are connected to the chain connecting blocks on the ends of each CROSS TUBE using the 5/16" Grade 8 bolts and nuts supplied.

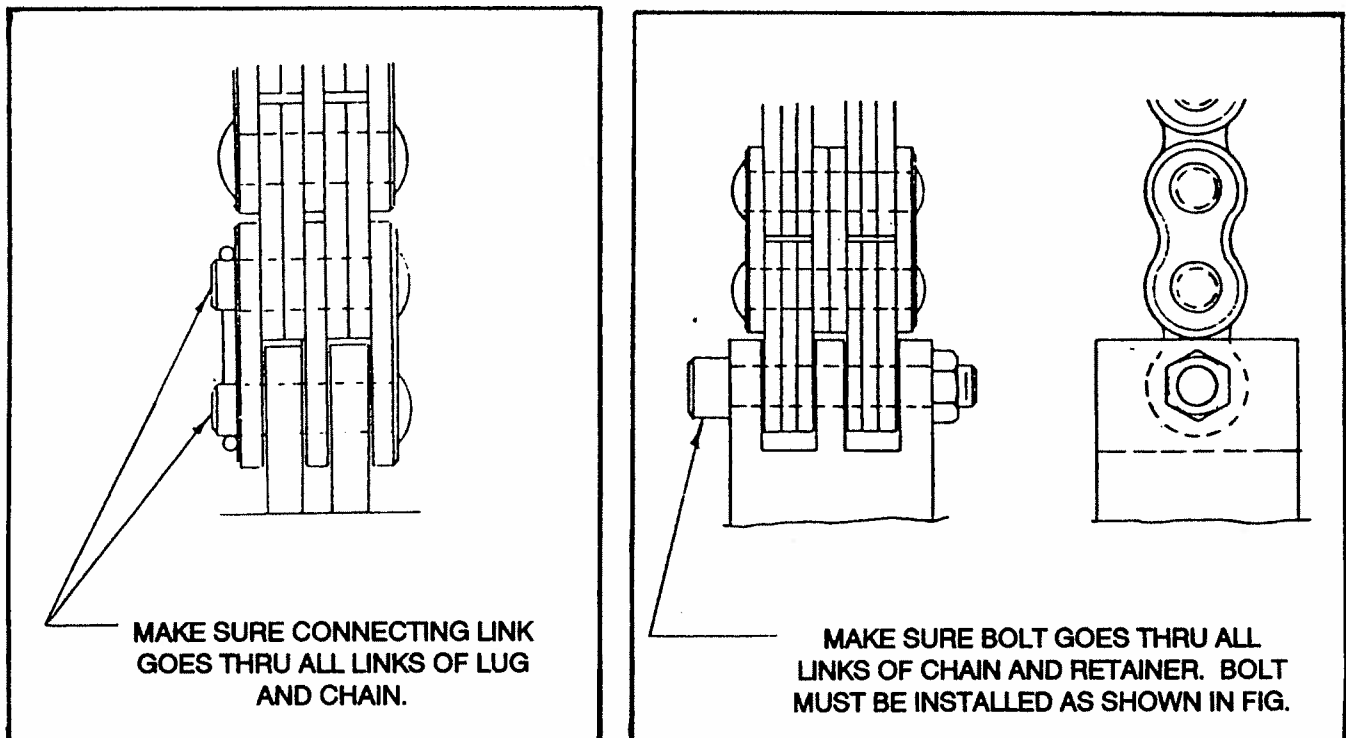

OFFSIDE CHAINS should be first connected to the bottom of the POWER SIDE POSTS then through the CROSS TUBES to the top of the OFFSIDE POSTS.

WARNING: Pay careful attention when connecting chains making sure bolts and pins pass through all leaves in the chain.

CHAIN ROUTING DIAGRAM

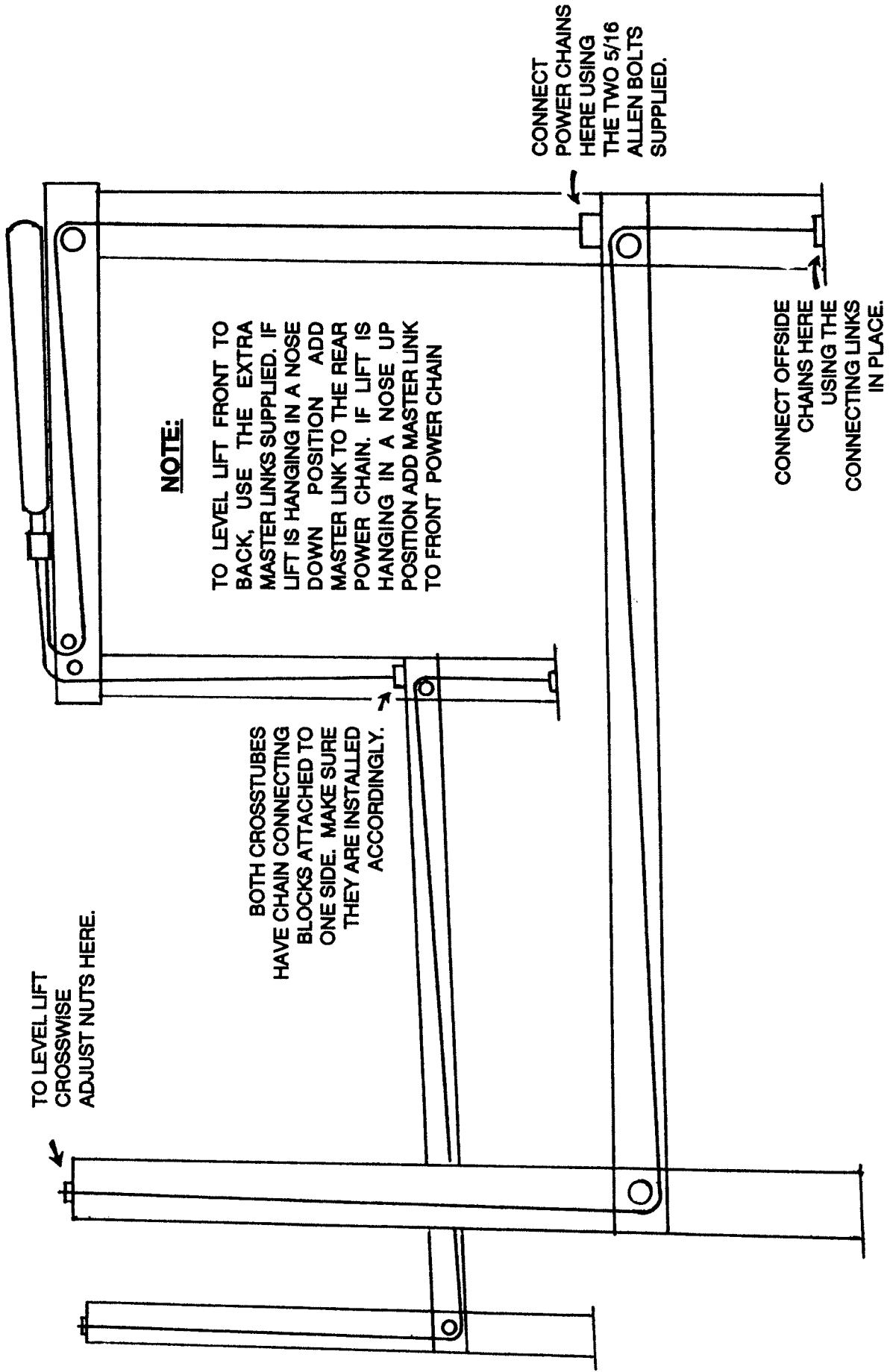

STEP FIVE

POSITIONING RAMPS

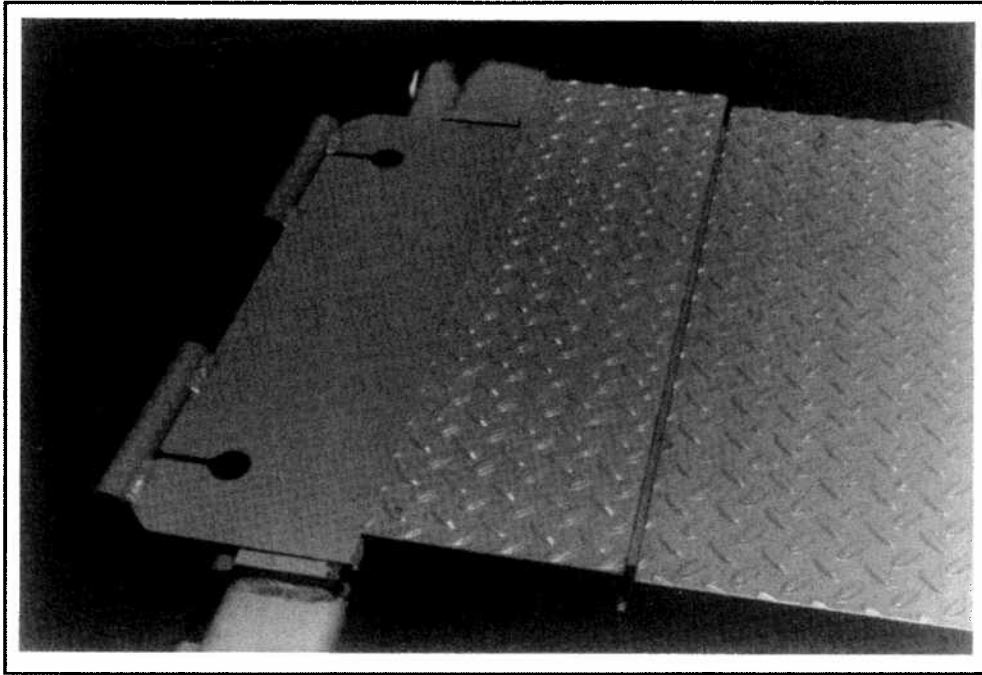

Place STATIONARY RAMP in position between locating blocks welded to the CROSS TUBES and adjacent to POWER BEAM. Place ADJUSTABLE RAMP in position on CROSS TUBES.

NOTE: Position stationary ramp so that the bulkhead air fitting is adjacent to power unit.

MODELS WITH BUILT IN SCISSORS - The STATIONARY RAMP will have a hydraulic fitting protruding from the side. This **must** be placed directly adjacent to the POWER UNIT.

NOTE: Upon installation of ramps, be sure that both CROSS TUBES are pushed inward so that they are approximately 1/4" from the ends of each ramp (See drawing below).

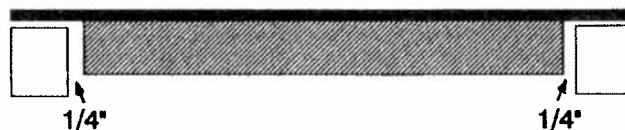

STEP SIX

POWER UNIT INSTALLATION INITIAL START UP

OIL IS NOT SUPPLIED WITH LIFT. SAE-10 HYDRAULIC OIL IS RECOMMENDED. IMPROPER OR DIRTY OIL WILL CAUSE PUMP DAMAGE.

NOTE: The manufacturer recommends that a cover be used over the POWER UNIT if the lift is installed outdoors. **Damage to motor caused by water or other liquids such as detergents, acid, etc., is not covered under warranty.**

Connect the POWER UNIT to the FRONT POWER POST using the four (4) 5/16" x 1" bolts and locking nuts supplied.



Remove plastic plug here and install POWER FITTING

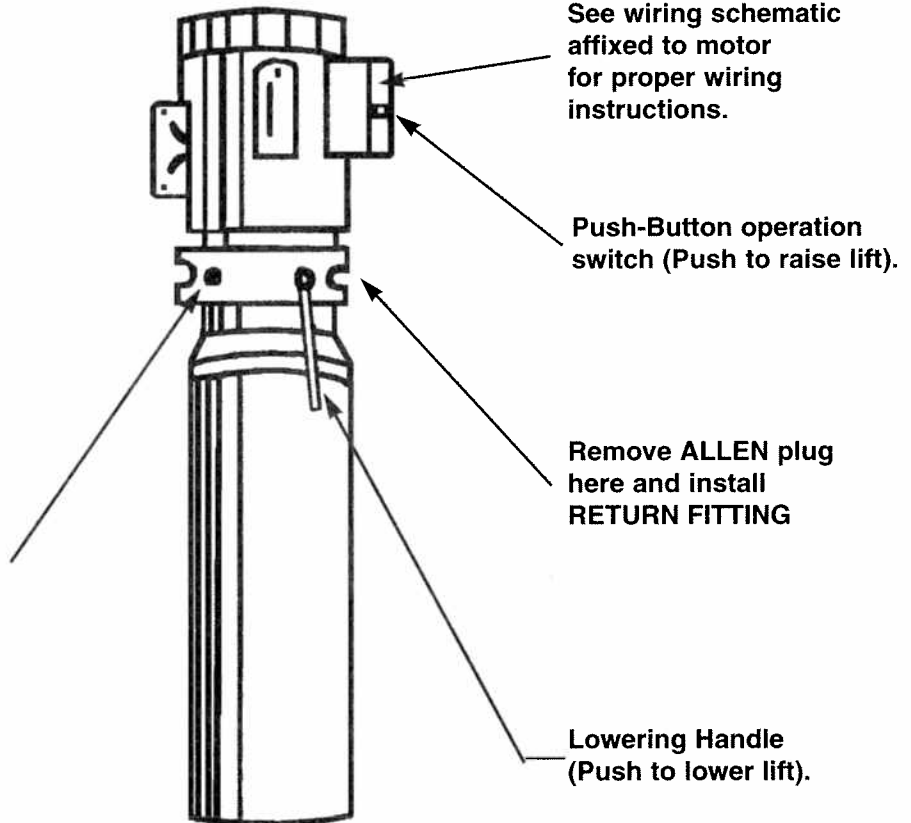

NOTE: Electrical connections must be made by qualified electrician's only!

Damage to motor caused by faulty wiring is not covered under warranty. Voltage required to operate - 220 VAC single phase. For questions concerning electrical connections consult factory.

Once hoses are connected, fill POWER UNIT with **3-1/2 GALLONS OF HYDRAULIC OIL. DO NOT EXCEED THIS AMOUNT AT THIS TIME.**

Test POWER UNIT by depressing button. If motor sounds like it is operating properly, release button. **DO NOT RAISE LIFT.** If motor does not run, stop immediately and check connections.

STEP SEVEN

HOSE CONNECTIONS

NOTE: Connect hoses as described below using the diagram that is similar to your unit. It may be necessary to remove Allen plugs prior to installation of some hose fittings.

STANDARD MODELS

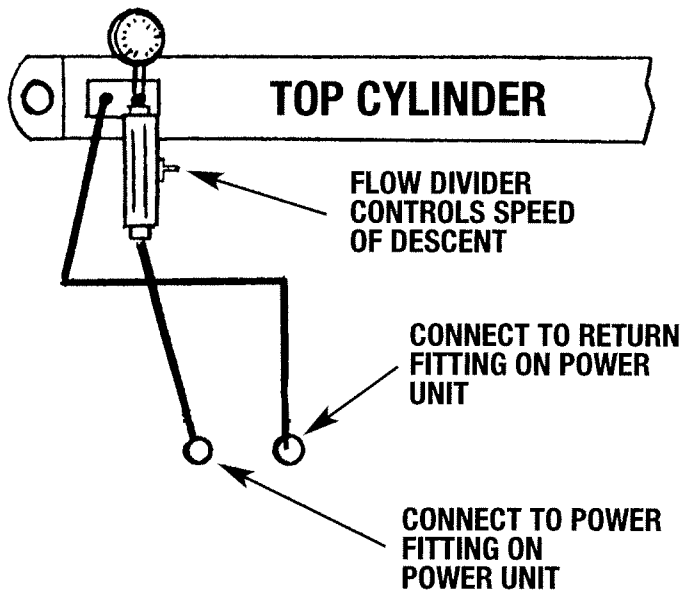

SCISSOR MODELS

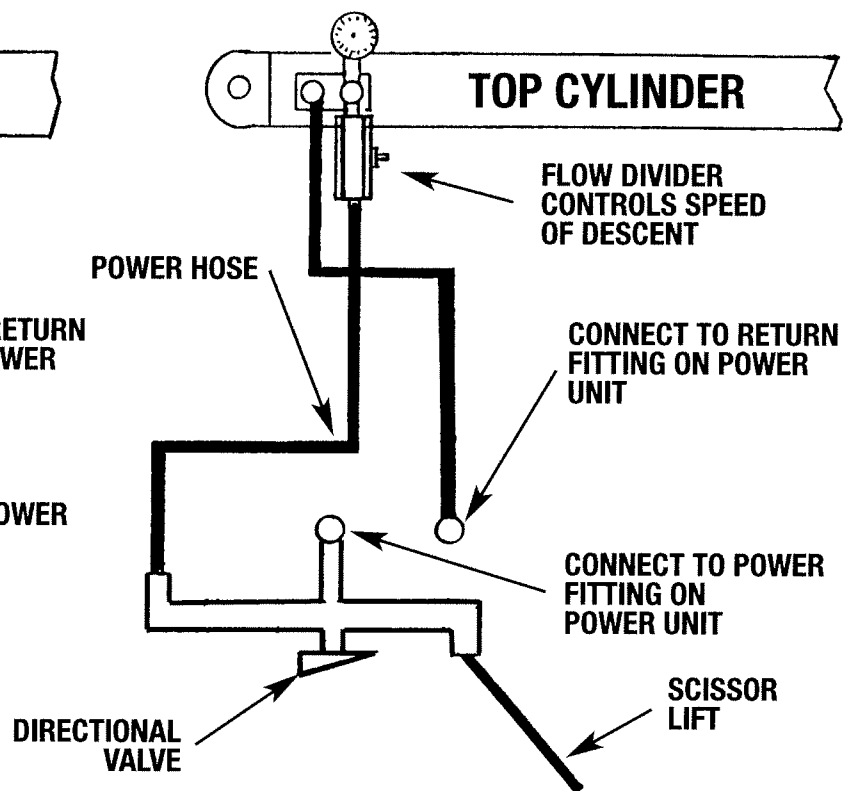

FOUR POST MODELS WITH BUILT-IN SCISSORS - The hydraulic hose that connects both scissor assemblies together, is stored underneath the ADJUSTABLE RAMP during shipment. Unwind hose. Route hose through the cutout in the side of the ADJUSTABLE RAMP. Connect to the hose protruding out of the STATIONARY RAMP using the double male fitting supplied. Teflon tape is recommended.

IMPORTANT! At this time, remove any steel banding material that secured scissors assemblies in shipment.

STEP EIGHT

SAFETY ASSEMBLIES

Route the AIR HOSE for the SAFETY ASSEMBLIES as outlined on the following page. Be sure to route the hose through tubing on the CROSS TUBE to conceal hose and protect it from damage.

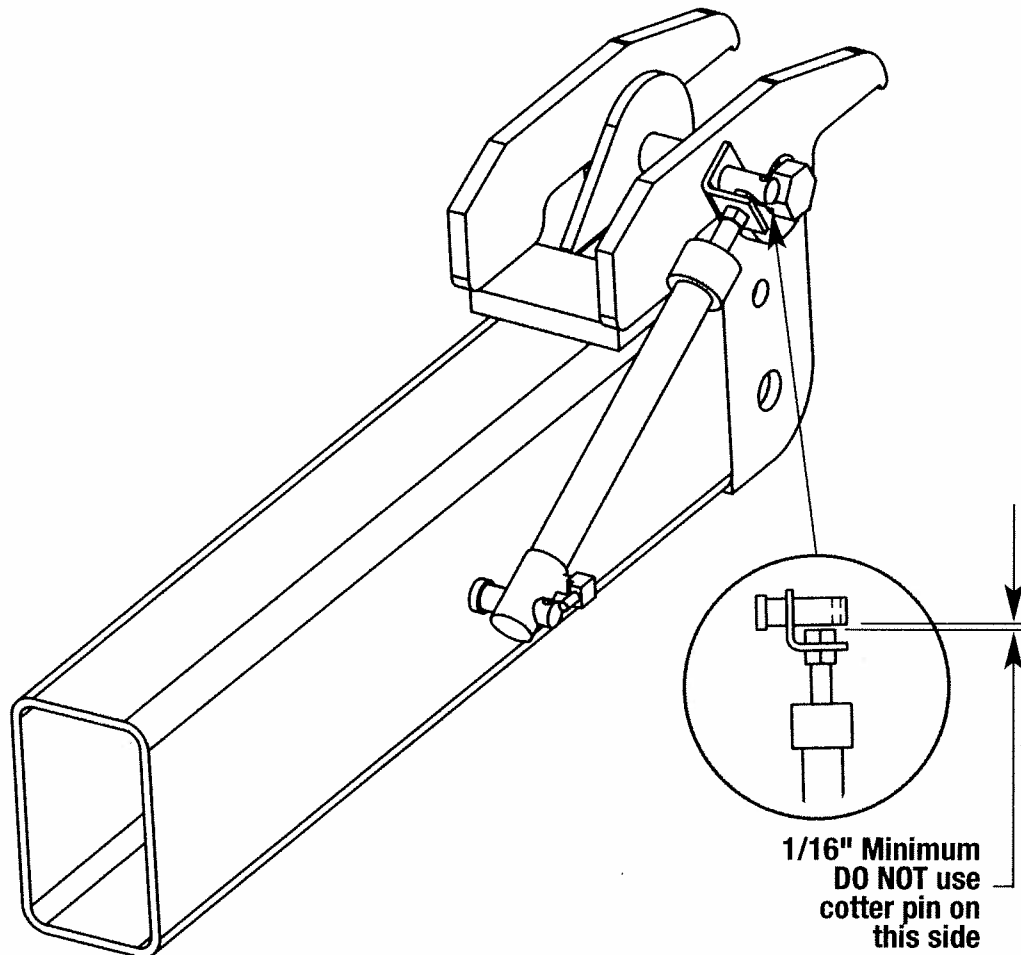

Before lowering the lift, each PRIMARY SAFETY must be raised to its fullest extent which will enable the safeties to clear the lattice descent. Once the lift reaches the floor all of the safeties will automatically reset.

LEVELING THE LIFT

The lift should be level as it is suspending from the chains (not resting on the locks). Raise the lift until it is approximately three feet from the ground. Place a level on the CROSS TUBES. If the lift appears to be out of level, make adjustments by tightening the nut to the cross tube chains located on the top of the off-side posts.

NOTE: There should be at least 1/4" of the threads on the bolt protruding from the upper edge of the Nylok nut.

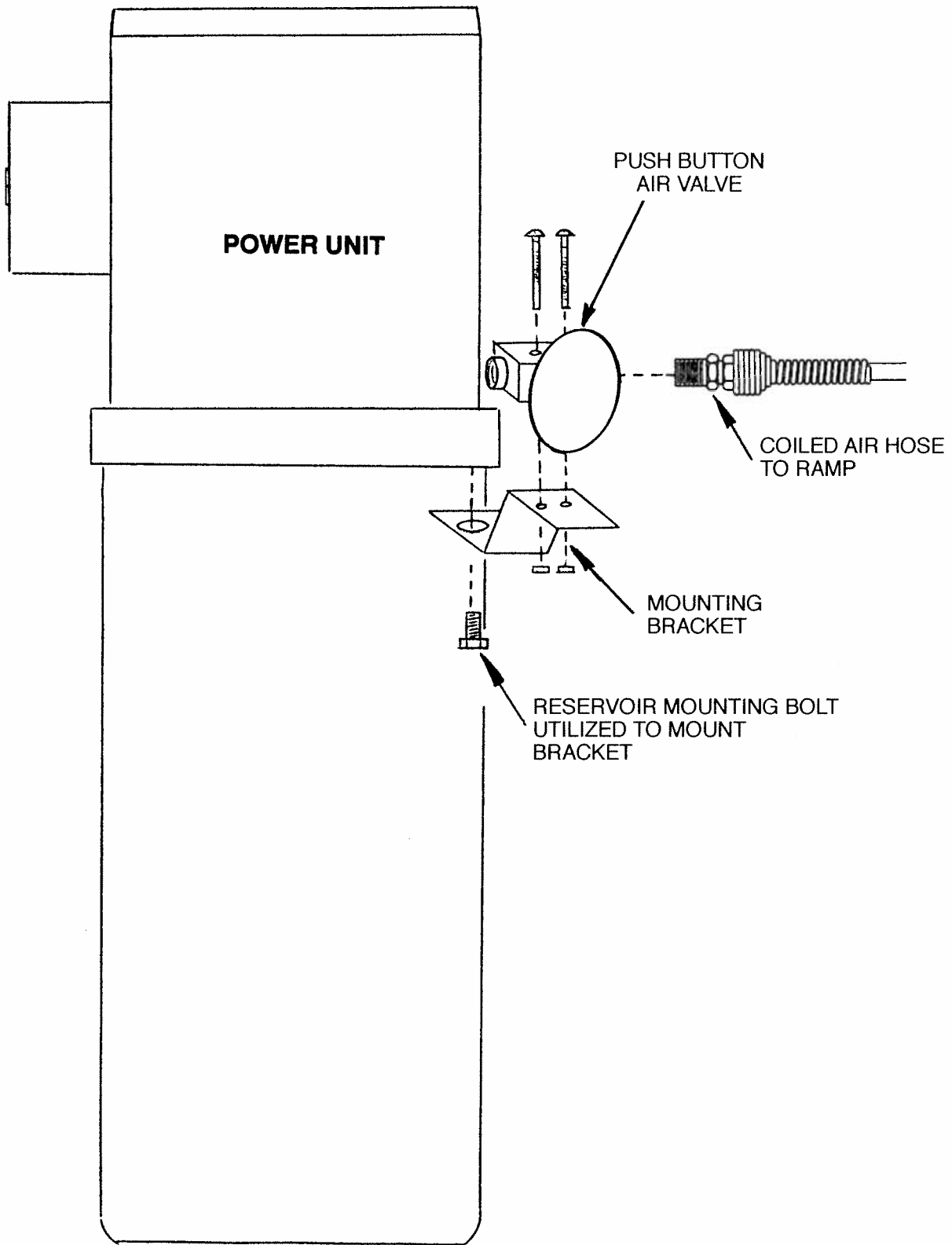

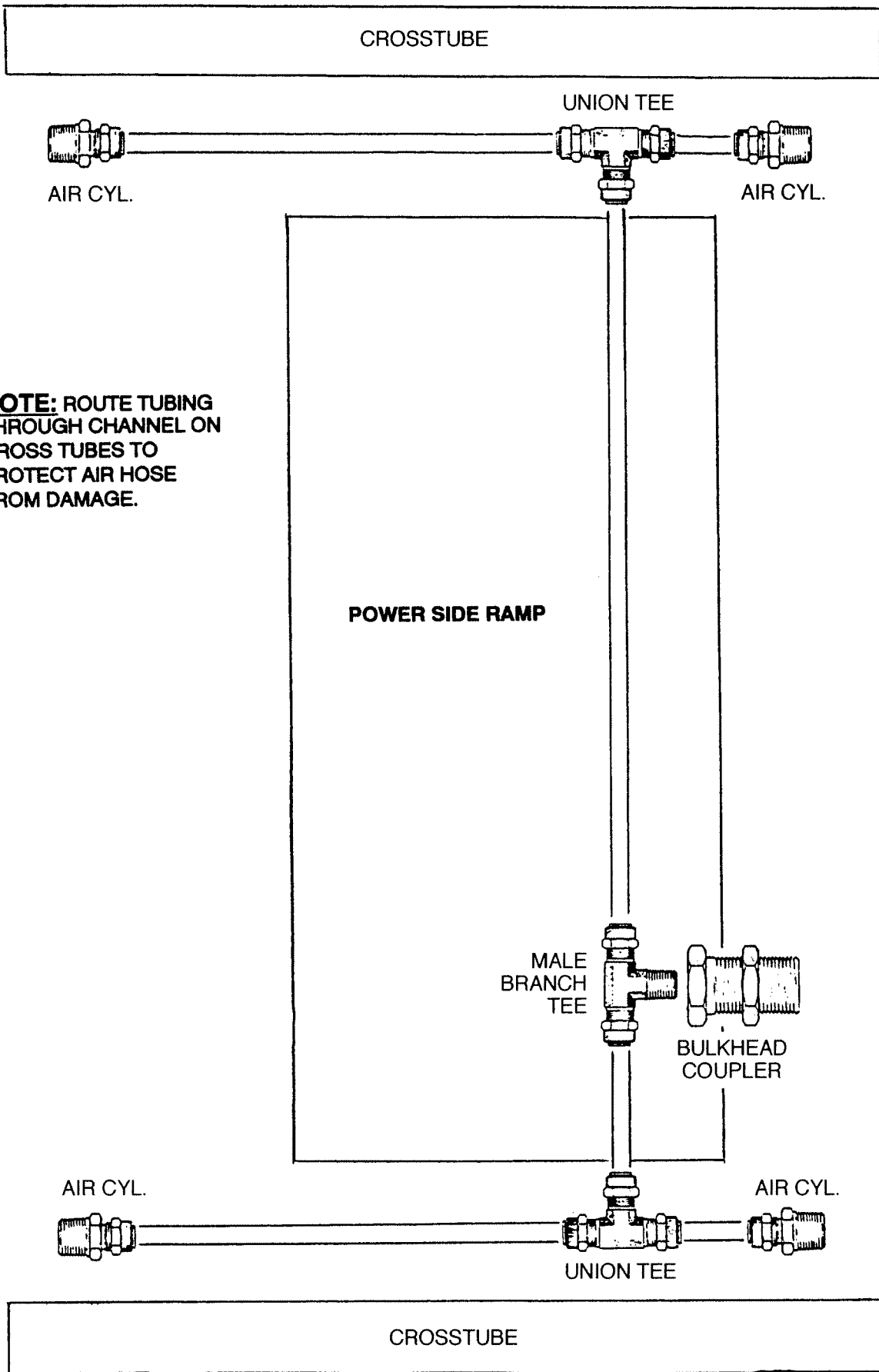

STEP NINE

INSTALLING RAMP LOCKS

CAUTION!

If you are using more than one rolling bridge or jack assembly at one time on your lift, then it is important that two RAMP LOCK BRACKETS be installed as shown below. The brackets are to prevent runways from "flipping" over when the entire weight of the vehicle is elevated off of the runways and transferred to the inside edges of the ramp rails. Brackets should be installed at the front end of the lift.

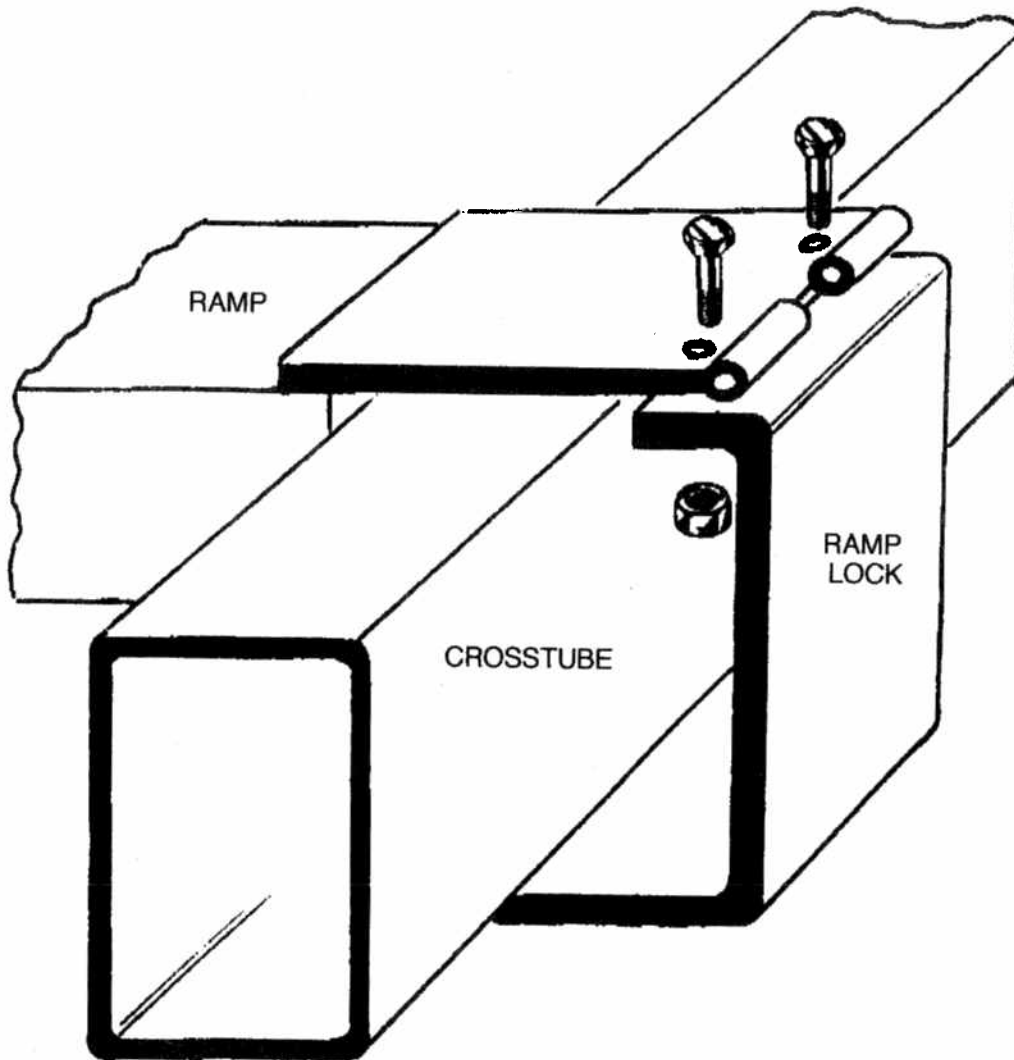

WARNING:

**FAILURE TO INSTALL RAMP LOCKS CAN CAUSE SEVERE PERSONAL INJURY
AND/OR DAMAGE TO EQUIPMENT**

STEP TEN

START-UP OF HYDRAULIC SYSTEM

Voltage - 220 VAC - Single Phase / Oil - SAE 10 Wt.

1. After your lift has been assembled per assembly instructions and unit is ready for operation, follow steps below to start the hydraulic operation.
2. Remove filler cap on the **POWER UNIT** and fill reservoir to approximately 1" below filling port.
3. On lifts with built in scissors check to make sure directional valve is pointing to "MAIN LIFT".
4. Commence lifting unit with no load by depressing button on motor. Disengage safeties and lower lift by actuating lowering handle.
5. Raise lift again adding oil as needed. Keep adding oil only enough to get lift to raise just above top lattice. **If reservoir is too full, oil will seep from filling port on descent.**
6. Check for leaks.
7. Lower unit by actuating release control.
8. Raise and lower unit two to three times to assure that all of the air has been flushed through the lines.
9. Install both drive-up ramps and front tire stops.
10. Cycle unit up and down with vehicle on lift and continue to check for leaks.
11. Unit is ready for operation.

OPERATION

1. To raise the lift, press and hold button on POWER UNIT until desired working height is obtained.
2. Be sure safeties are engaged before moving under the lift.
3. To lower the lift, first raise until the safeties can be disengaged. Lower lift paying careful attention making sure vehicle remains level at all times.
4. To raise scissors, rotate directional valve to "SCISSOR-LIFT" and depress button. Raise until scissors lock in the fully raised position.
5. To lower scissor lift, raise slightly, then pull the release handle and commence lowering by actuating release control.

MAINTENANCE SCHEDULE

MONTHLY:

1. Re-torque the anchor bolts to 60-80 ft. lbs.
2. Lubricate chains/cable with spray lubricant.
3. Check all chain connectors, bolts and pins to insure proper mounting.
4. Make a visual inspection of all hydraulic hoses/lines for possible wear or interference.
5. Lubricate all rollers.
6. Lubricate air cylinders with multi purpose oil.

IMPORTANT

ALL ROLLERS SHOULD BE LUBRICATED MONTHLY WITH 90 Wt. GEAR OIL

CAUTION

ALL ANCHOR BOLTS SHOULD TAKE FULL TORQUE. If any of the bolts do not function for any reason, the lift should be shutdown until the bolt has been replaced.

EVERY SIX (6) MONTHS:

1. Make a visual inspection of all moving parts for possible wear, interference or damage.
2. Check all rollers for proper lubrication. If rollers seem to be dragging during lifting or lowering, lightly oil the axle.
3. Check and adjust as necessary, equalizer tension to insure level lifting.
4. Check columns for plumbness. See STEP-4

TROUBLE SHOOTING

TROUBLE	CAUSE	REMEDY
Motor does not run.	<ol style="list-style-type: none"> 1. Check fuse on circuit breaker. 2. Check for correct voltage to motor. 3. Inspect all wiring connections. 4. Microswitch burned out. 5. Overhead limit switch burned out. 6. Motor windings burned out. 	<ol style="list-style-type: none"> 1. Replace blown fuse or reset circuit breaker. 2. Supply correct voltage to motor. 3. Repair and insulate all connections. 4. Replace microswitch. 5. Replace switch. 6. Replace motor.
Motor runs but will not raise lift.	<ol style="list-style-type: none"> 1. Motor runs in reverse rotation. 2. Open lowering valve. 3. Pump sucking air 4. Suction stub off pump. 5. Low oil level. 	<ol style="list-style-type: none"> 1. Change motor rotation by reversing motor leads. 2. Repair or replace lowering valve. 3. Tighten all suction line fittings. 4. Replace suction stub. 5. Fill tank.
Motor runs—raises unloaded lift but will not raise vehicle.	<ol style="list-style-type: none"> 1. Motor running on low voltage. 2. Trash in lowering valve. 3. Improper relief valve adjustment. 4. Overloading lift. 	<ol style="list-style-type: none"> 1. Supply correct voltage to motor. 2. Clean lowering valve. 3. Replace relief valve cartridge. 4. Check vehicle weight and/or balance vehicle weight on lifts.
Lift slowly settles down.	<ol style="list-style-type: none"> 1. Trash in check valve seat. 2. Trash in lowering valve seat. 3. External oil leaks. 	<ol style="list-style-type: none"> 1. Clean check valve. 2. Clean lowering valve. 3. Repair external leaks.
Slow lifting speed or oil blowing out filler breather cap.	<ol style="list-style-type: none"> 1. Air mixed with oil. 2. Air mixed with oil suction. 3. Oil return tube loose. 	<ol style="list-style-type: none"> 1. Change oil. 2. Tighten all suction line fittings. 3. Reinstall oil return tube.
Lift going up unlevel.	<ol style="list-style-type: none"> 1. Chains out of adjustment. 2. Lift installed on unlevel floor. 	<ol style="list-style-type: none"> 1. Adjust chains to correct . 2. Shim lift to level columns (Not to exceed 1/2"). If over 1/2" break out floor and level. See Installation Instructions
Anchors will not stay tight.	<ol style="list-style-type: none"> 1. Holes drilled oversize. 2. Concrete floor thickness or holding strength not sufficient. 	<ol style="list-style-type: none"> 1. Use a fast setting cement to pour into oversize holes and reset anchors -or-relocate lift using a new bit to drill holes. 2. Break out old concrete and repour new pads for lift-See Installation Instructions
Locking latches do not operate.	<ol style="list-style-type: none"> 1. Dog pivot pins rusted. (Usually occurs on outside installations or in high humidity areas such as vehicle wash bays.) 2. Dog pivot spring broken. 	<ol style="list-style-type: none"> 1. Raise lift to full travel, oil latch mechanism through opening on top of latch cover. Activate latch mechanism several times with reset lever to allow oil to penetrate. 2. Replace broken spring.

MAINTENANCE RECORD AND NOTES

Bend-Pak®
ABOVE-GROUND LIFTS

1645 Lemonwood Drive • Santa Paula, California 93060 • Tel: (805) 933-9970 • Fax: (805) 933-9160
www.bendpak.com